

# 1.0SMBJ Series

## Surface Mount – 1000W

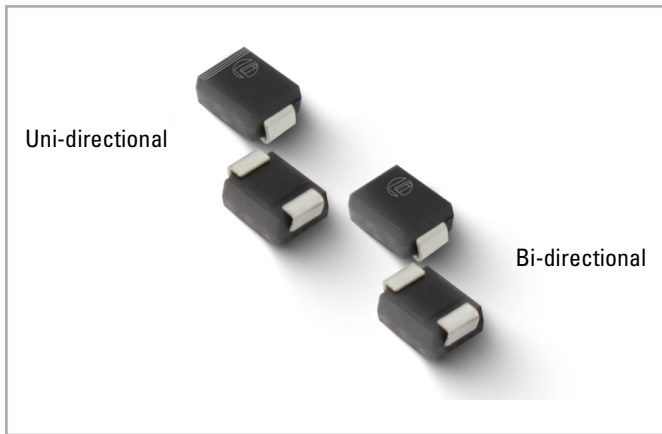

### Additional Information



Resources



Accessories



Samples

### Maximum Ratings and Thermal Characteristics

( $T_A=25^{\circ}\text{C}$  unless otherwise noted)

Parameter	Symbol	Value	Unit
Peak Pulse Power Dissipation by 10/1000 $\mu\text{s}$ Waveform(Fig.1)(Note 1)(Note 2) -Single Die Parts	$P_{PPM}$	1000	W
Power Dissipation on Infinite Heat Sink at $T_L=50^{\circ}\text{C}$	$P_D$	5	W
Peak Forward Surge Current, 8.3ms Single Half Sine Wave (Note 3)	$I_{FSM}$	100	A
Maximum Instantaneous Forward Voltage at 50A for Unidirectional Only	$V_F$	3.5	V
Operating Temperature Range	$T_J$	-55 to 150	$^{\circ}\text{C}$
Storage Temperature Range	$T_{STG}$	-55 to 150	$^{\circ}\text{C}$
Typical Thermal Resistance Junction to Lead	$R_{\theta JL}$	20	$^{\circ}\text{C}/\text{W}$
Typical Thermal Resistance Junction to Ambient	$R_{\theta JA}$	100	$^{\circ}\text{C}/\text{W}$

#### Notes:

1. Non-repetitive current pulse, per Fig.3 and derated above  $T_J$  (initial)  $=25^{\circ}\text{C}$  per Fig. 2
2. Mounted on copper pad area of 0.2x0.2" (5.0 x 5.0mm) to each terminal.
3. Measured on 8.3ms single half sine wave or equivalent square wave for unidirectional device only, duty cycle=4 per minute maximum.

### Description

The 1.0SMBJ series is designed specifically to protect sensitive electronic equipment from voltage transients induced by lightning and other transient voltage events.

### Features

- 1000W peak pulse power capability at 10/1000 $\mu\text{s}$  waveform, repetition rate (duty cycles):0.01%
- Excellent clamping capability
- Low incremental surge resistance
- Typical  $I_R$  less than 1 $\mu\text{A}$  when  $V_B \text{ min}>12\text{V}$
- Optimized surface mount footprint for minimal PCB space impact
- Low profile package
- Typical failure mode due to exceeding maximum ratings is a short circuit condition
- Whisker test conducted based on Table 4a and 4c of JEDEC JESD201A
- ESD protection of data lines in accordance with IEC 61000-4-2, 30kV(Air), 30kV (Contact)
- EFT protection of data lines in accordance with IEC61000-4-4
- Built-in strain relief
- Fast response time: typically less than 1.0ps from 0V to  $V_B \text{ min}$
- High temperature to reflow soldering guaranteed: 260 $^{\circ}\text{C}$ /20~40sec.
- $V_B @ T_J = V_B @ 25^{\circ}\text{C} \times (1 + \alpha T \times (T_J - 25))$  ( $\alpha$  T:Temperature Coefficient, typical value is 0.1%)
- Meet MSL level1, per J-STD-020, LF maximum peak of 260 $^{\circ}\text{C}$
- Matte tin lead-free plated
- Halogen free and RoHS compliant
- Pb-free E3 means 2nd level interconnect is Pb-free and the terminal finish material is tin(Sn) (IPC/JEDEC J-STD 609A.01)

### Applications

TVS devices are ideal for the protection of I/O Interfaces,  $V_{CC}$  bus and other vulnerable circuits used in Telecom, Computer, Industrial and Consumer electronic applications.

### Functional Diagram

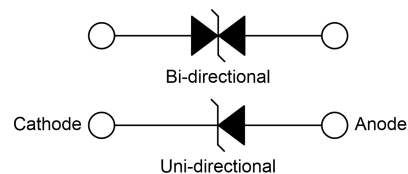

# 1.0SMBJ Series

## Surface Mount – 1000W

### Electrical Characteristics ( $T_A=25^\circ\text{C}$ unless otherwise noted)

Part Number		Device Marking Code		Reverse Stand-Off Voltage	Breakdown Voltage @ $I_T$		Test Current	Maximum Clamping Voltage @ $I_{PP}$	Peak Pulse Current	Reverse Leakage @ $V_R$
Uni.	Bi.	Uni.	Bi.	$V_R(V)$	$V_{B\ Min.}(V)$	$V_{B\ Max.}(V)$	$I_T(mA)$	$V_C(V)$	$I_{PP}(A)$	$I_R(\mu A)$
1.0SMBJ5.0A	1.0SMBJ5.0CA	KE·	AE·	5.0	6.40	7.00	10	9.2	108.70	800
1.0SMBJ6.0A	1.0SMBJ6.0CA	KG·	AG·	6.0	6.67	7.37	10	10.3	97.10	800
1.0SMBJ6.5A	1.0SMBJ6.5CA	KK·	AK·	6.5	7.22	7.98	10	11.2	89.30	500
1.0SMBJ7.0A	1.0SMBJ7.0CA	KM·	AM·	7.0	7.78	8.60	10	12.0	83.40	200
1.0SMBJ7.5A	1.0SMBJ7.5CA	KP·	AP·	7.5	8.33	9.21	1	12.9	77.60	100
1.0SMBJ8.0A	1.0SMBJ8.0CA	KR·	AR·	8.0	8.89	9.83	1	13.6	73.60	50
1.0SMBJ8.5A	1.0SMBJ8.5CA	KT·	AT·	8.5	9.44	10.40	1	14.4	69.50	20
1.0SMBJ9.0A	1.0SMBJ9.0CA	KV·	AV·	9.0	10.00	11.10	1	15.4	65.00	10
1.0SMBJ10A	1.0SMBJ10CA	KX·	AX·	10.0	11.10	12.30	1	17.0	58.90	5
1.0SMBJ11A	1.0SMBJ11CA	KZ·	AZ·	11.0	12.20	13.50	1	18.2	55.00	1
1.0SMBJ12A	1.0SMBJ12CA	LE·	BE·	12.0	13.30	14.70	1	19.9	50.30	1
1.0SMBJ13A	1.0SMBJ13CA	LG·	BG·	13.0	14.40	15.90	1	21.5	46.60	1
1.0SMBJ14A	1.0SMBJ14CA	LK·	BK·	14.0	15.60	17.20	1	23.2	43.20	1
1.0SMBJ15A	1.0SMBJ15CA	LM·	BM·	15.0	16.70	18.50	1	24.4	41.00	1
1.0SMBJ16A	1.0SMBJ16CA	LP·	BP·	16.0	17.80	19.70	1	26.0	38.50	1
1.0SMBJ17A	1.0SMBJ17CA	LR·	BR·	17.0	18.90	20.90	1	27.6	36.30	1
1.0SMBJ18A	1.0SMBJ18CA	LT·	BT·	18.0	20.00	22.10	1	29.2	34.30	1
1.0SMBJ20A	1.0SMBJ20CA	LV·	BV·	20.0	22.20	24.50	1	32.4	30.90	1
1.0SMBJ22A	1.0SMBJ22CA	LX·	BX·	22.0	24.40	26.90	1	35.5	28.20	1
1.0SMBJ24A	1.0SMBJ24CA	LZ·	BZ·	24.0	26.70	29.50	1	38.9	25.80	1
1.0SMBJ26A	1.0SMBJ26CA	ME·	CE·	26.0	28.90	31.90	1	42.1	23.80	1
1.0SMBJ28A	1.0SMBJ28CA	MG·	CG·	28.0	31.10	34.40	1	45.4	22.10	1
1.0SMBJ30A	1.0SMBJ30CA	MK·	CK·	30.0	33.30	36.80	1	48.4	20.70	1
1.0SMBJ33A	1.0SMBJ33CA	MM·	CM·	33.0	36.70	40.60	1	53.3	18.80	1
1.0SMBJ36A	1.0SMBJ36CA	MP·	CP·	36.0	40.00	44.20	1	58.1	17.30	1
1.0SMBJ40A	1.0SMBJ40CA	MR·	CR·	40.0	44.40	49.10	1	64.5	15.60	1
1.0SMBJ43A	1.0SMBJ43CA	MT·	CT·	43.0	47.80	52.80	1	69.4	14.50	1
1.0SMBJ45A	1.0SMBJ45CA	MV·	CV·	45.0	50.00	55.30	1	72.7	13.80	1
1.0SMBJ48A	1.0SMBJ48CA	MX·	CX·	48.0	53.30	58.90	1	77.4	13.00	1
1.0SMBJ51A	1.0SMBJ51CA	MZ·	CZ·	51.0	56.70	62.70	1	82.4	12.20	1
1.0SMBJ54A	1.0SMBJ54CA	NE·	DE·	54.0	60.00	66.30	1	87.1	11.50	1
1.0SMBJ58A	1.0SMBJ58CA	NG·	DG·	58.0	64.40	71.20	1	93.6	10.70	1
1.0SMBJ60A	1.0SMBJ60CA	NK·	DK·	60.0	66.70	73.70	1	96.8	10.40	1
1.0SMBJ64A	1.0SMBJ64CA	NM·	DM·	64.0	71.10	78.60	1	103.0	9.84	1
1.0SMBJ70A	1.0SMBJ70CA	NP·	DP·	70.0	77.80	86.00	1	113.0	8.84	1
1.0SMBJ75A	1.0SMBJ75CA	NR·	DR·	75.0	83.30	92.10	1	121.0	8.34	1
1.0SMBJ78A	1.0SMBJ78CA	NT·	DT·	78.0	86.70	95.80	1	126.0	8.00	1

**Notes:**

For bidirectional type having  $V_R$  of 10 volts and less, the  $I_R$  limit is double.

# 1.0SMBJ Series

## Surface Mount – 1000W

### Ratings and Characteristic Curves ( $T_A=25^\circ\text{C}$ unless otherwise noted)

**Figure 1:**  
Peak Pulse Power Rating Curve

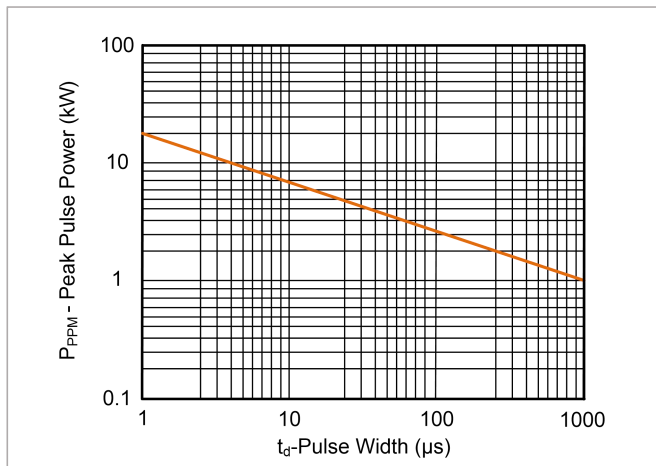

**Figure 2:**  
Pulse Derating Curve

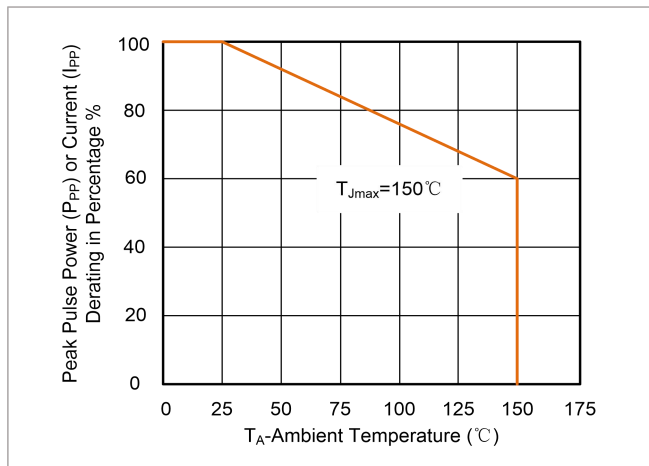

**Figure 3:**  
Pulse Waveform

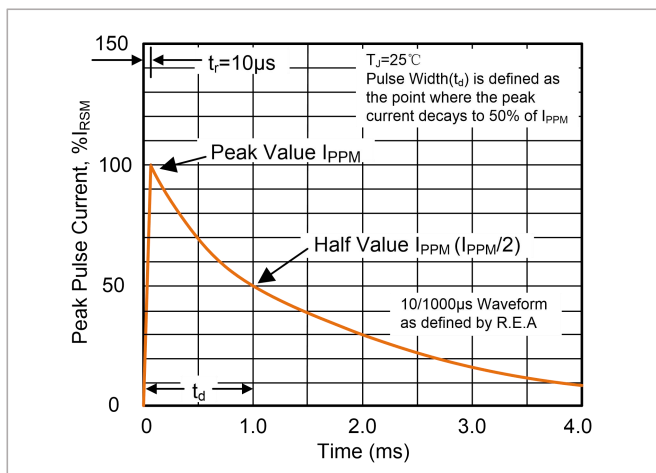

**Figure 4:**  
Typical Junction Capacitance

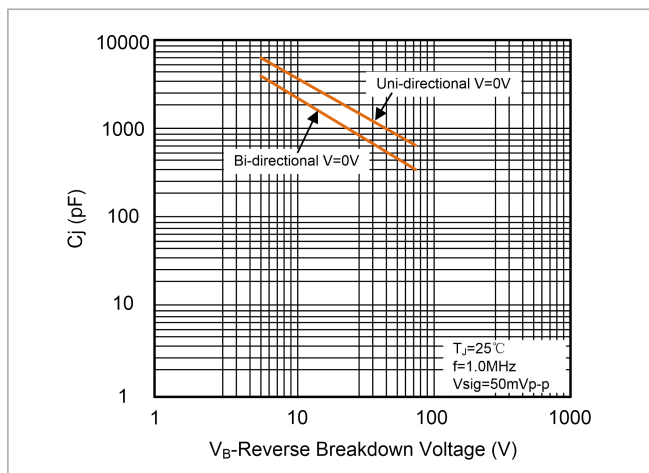

**Figure 5:**  
Steady State Power Dissipation Derating Curve

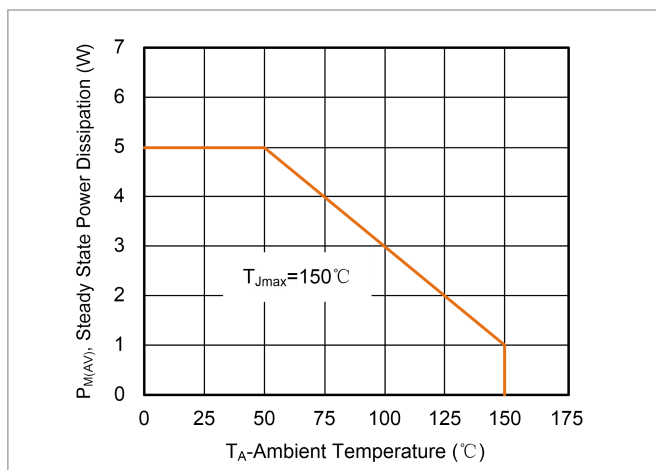

**Figure 6:**  
Maximum Non-Repetitive Forward Surge Current Uni-Directional

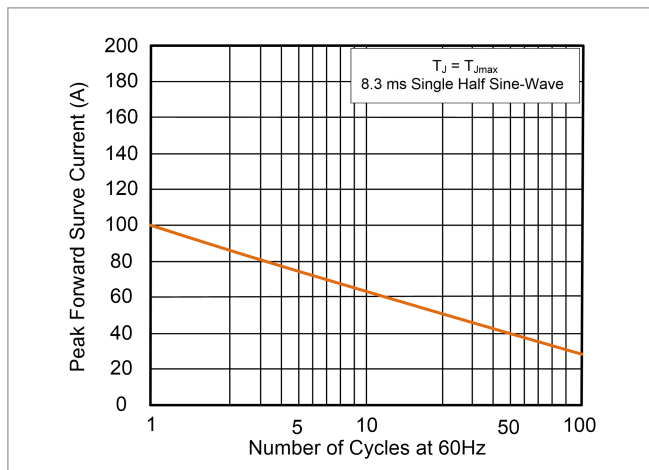

# 1.0SMBJ Series

## Surface Mount – 1000W

### Soldering Parameters

<b>Reflow Condition</b>		Lead-free assembly
<b>Pre Heat</b>	-Temperature Min ( $T_{S\ min}$ )	150°C
	-Temperature Max ( $T_{S\ max}$ )	200°C
	-Time (min to max) ( $t_s$ )	60 – 180 secs
<b>Average ramp-up rate(Liquidus Temp (<math>T_L</math>) to peak <math>T_{S\ (max)}</math>) to <math>T_L</math>-Ramp-up Rate</b>		3°C/second max.
<b>Reflow</b>	-Temperature ( $T_L$ ) (Liquidus)	217°C
	-Time (min to max) ( $t_L$ )	60-150 seconds
<b>Peak Temperature (<math>T_P</math>)</b>		260°C
<b>Time within 5°C of actual Peak Temperature (<math>t_p</math>)</b>		20-40 seconds
<b>Ramp-down Rate</b>		6°C/second max.
<b>Time 25°C to Peak Temperature</b>		8 minutes max.
<b>Do not exceed</b>		260°C

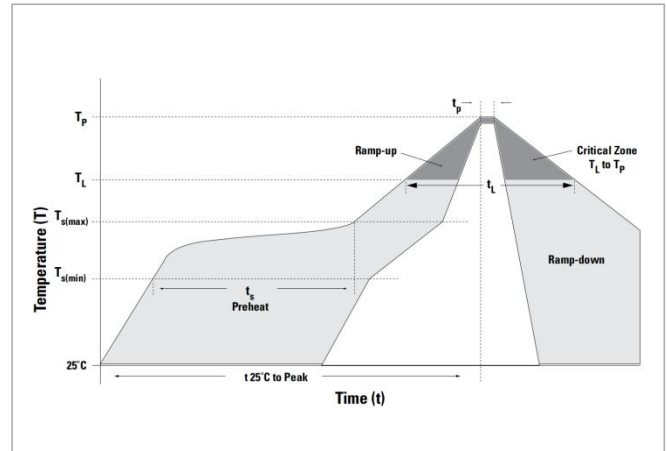

### Dimensions

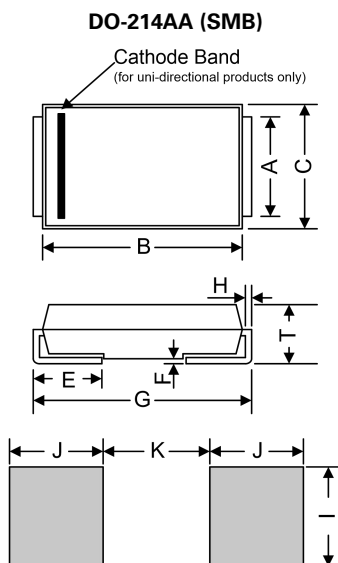

Symbol	Millimeters		Inches	
	Min.	Max.	Min.	Max.
A	1.930	2.200	0.076	0.086
B	4.060	4.570	0.160	0.180
C	3.300	3.940	0.130	0.155
E	0.760	1.520	0.030	0.060
F	-	0.203	-	0.008
G	5.100	5.480	0.201	0.216
H	0.152	0.305	0.006	0.012
T	2.160	2.440	0.085	0.096
I	2.260	-	0.089	-
J	2.160	-	0.085	-
K	-	2.740	-	0.107

### Part Numbering System

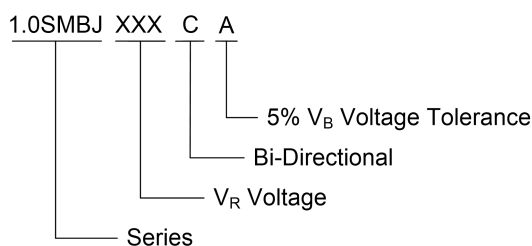

### Part Marking System

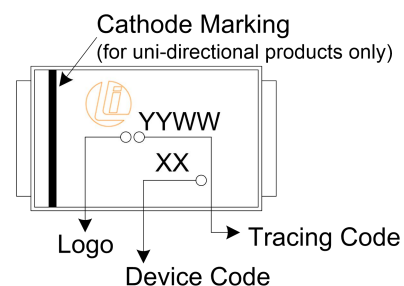

# 1.0SMBJ Series

## Surface Mount – 1000W

### Packaging

Part number	Component Package	Quantity	Packaging Option	Packaging Specification
1.0SMBJxxxXX	DO-214AA	3000	Tape & Reel - 12mm tape/13" reel	EIA STD RS-481

### Tape and Reel Specification

Tape

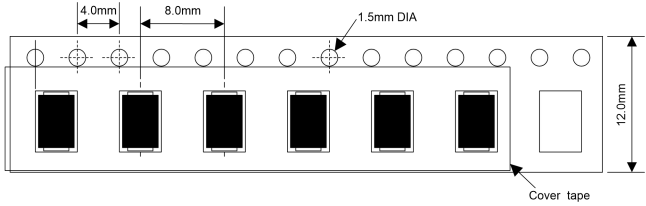

For Uni-Devices

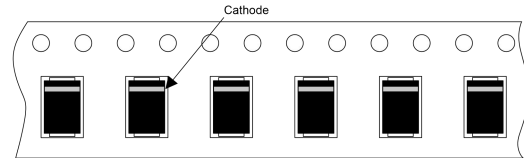

13 Inches Reel

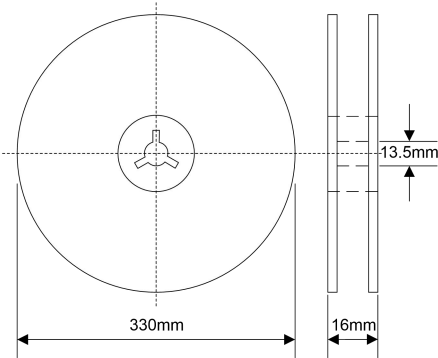

Quantity: 3000pcs/reel

**Disclaimer Notice** - Information furnished is believed to be accurate and reliable. However, users should independently evaluate the suitability of and test each product selected for their own applications. Liown products are not designed for, and may not be used in, all applications. Read complete Disclaimer Notice at <http://www.liownsemi.com>