

HP3KA-L Series

Axial Leaded – 3kA

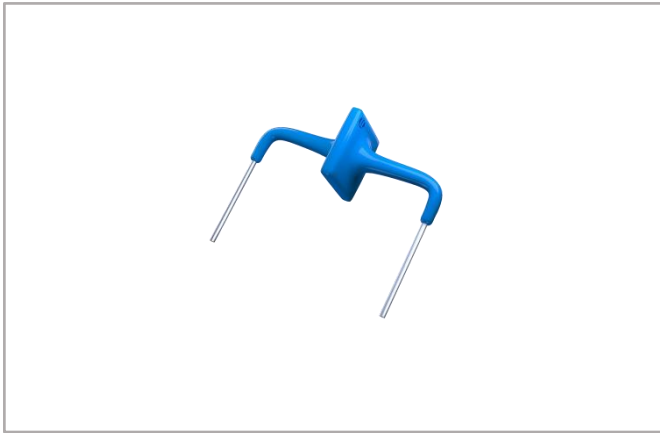

Description

The HP3KA-L series of high power TVS diode is specially designed for meeting severe surge test environment of both AC and DC line protection applications. It features a very fast response and ultra low clamping characteristics over traditional metal oxide varistor (MOV) solutions. They can be connected in series and / or parallel to create a very high surge current protection solution.

Features

- Very low clamping voltage
- Ultra compact: less than one-tenth the size of traditional discrete solutions
- Sharp breakdown voltage
- Low slope resistance
- Bi-directional
- Symmetric in leads width for easier soldering during assembly.
- Halogen-free
- RoHS compliant
- ESD protection of data lines in accordance with IEC 61000-4-2, 30kV(Air), 30kV (Contact)
- EFT protection of data lines in accordance with IEC61000-4-4
- Glass passivated junction
- Pb-free E4 means 2nd level interconnect is Pb-free and the terminal finish material is Silver

Additional Information



Resources



Accessories



Samples

Maximum Ratings and Thermal Characteristics

($T_A=25^\circ\text{C}$ unless otherwise noted)

Parameter	Symbol	Value	Unit
Operating Storage Temperature Range	T_{STG}	-55 to 125	$^\circ\text{C}$
Operating Junction Temperature Range	T_J	-55 to 150	$^\circ\text{C}$
Current Rating ¹	I_{PP}	3	kA

Notes:

1. Rated I_{PP} measured with 8/20 μs pulse

Functional Diagram



Electrical Characteristics ($T_A=25^\circ\text{C}$ unless otherwise noted)

Part Number	Reverse Stand-Off Voltage		Breakdown Voltage @ I_T		Test Current $I_T(\text{mA})$	Maximum Clamping Voltage @ I_{PP} $V_C(\text{V})$	Current Rating @8/20 μs $I_{PP}(\text{A})$	Reverse Leakage @ V_{DC} $I_R(\mu\text{A})$
	$V_{AC}(\text{V})$	$V_{DC}(\text{V})$	$V_{B.Min.}(\text{V})$	$V_{B.Max.}(\text{V})$				
HP3KA-12CL	8.5	12	14.0	16.0	1	28	3000	5
HP3KA-15CL	11	15	17.0	19.0	1	30	3000	5
HP3KA-20CL	14	20	22.0	24.5	1	40	3000	5
HP3KA-25CL	17	25	28.0	31.0	1	50	3000	5
HP3KA-30CL	21	30	33.0	36.5	1	60	3000	5
HP3KA-33CL	23	33	35.0	39.0	1	66	3000	5
HP3KA-38CL	27	38	40.5	49.5	1	69	3000	5
HP3KA-42CL	30	42	47.0	52.0	1	77	3000	5
HP3KA-58CL	40	58	64.0	72.0	1	110	3000	5
HP3KA-66CL	45	66	70.0	77.5	1	125	3000	5
HP3KA-76CL	54	76	85.0	94.0	1	140	3000	5
HP3KA-100CL	72	100	110.0	121.5	1	165	3000	5
HP3KA-133CL	100	133	147.0	162.5	1	220	3000	5
HP3KA-150CL	105	150	165.0	182.5	1	240	3000	5
HP3KA-170CL	130	170	180.0	199.0	1	260	3000	5
HP3KA-190CL	145	190	200.0	221.0	1	290	3000	5
HP3KA-200CL	150	200	222.0	245.5	1	330	3000	5
HP3KA-240CL	180	240	250.0	276.5	1	340	3000	5

HP3KA-L Series

Axial Leaded – 3kA

Part Number	Reverse Stand-Off Voltage		Breakdown Voltage @ I_T		Test Current	Maximum Clamping Voltage @ I_{PP}	Current Rating @8/20 μ s	Reverse Leakage @ V_{DC}
	$V_{AC}(V)$	$V_{DC}(V)$	$V_{B Min.}(V)$	$V_{B Max.}(V)$	$I_T(mA)$	$V_C(V)$	$I_{PP}(A)$	$I_R(\mu A)$
HP3KA-275CL	210	275	300.0	331.5	1	435	3000	5
HP3KA-300CL	230	300	330.0	365.0	1	470	3000	5
HP3KA-380CL	275	380	401.0	443.5	1	520	3000	5
HP3KA-430CL	310	430	440.0	486.5	1	625	3000	5
HP3KA-460CL	330	460	500.0	552.5	1	770	3000	5
HP3KA-500CL	385	500	558.0	617.0	1	868	3000	5
HP3KA-650CL	460	650	680.0	751.5	1	900	3000	5
HP3KA-1100CL	770	1100	1200.0	1326.5	1	2000	3000	5
HP3KA-1200CL	849	1200	1300.0	1502.0	1	2180	3000	5

Notes: Using 8/20 μ s wave shape as defined in IEC 61000-4-5.

Wave Solder Profile

Figure 1:
Wave Soldering Temperature Profile

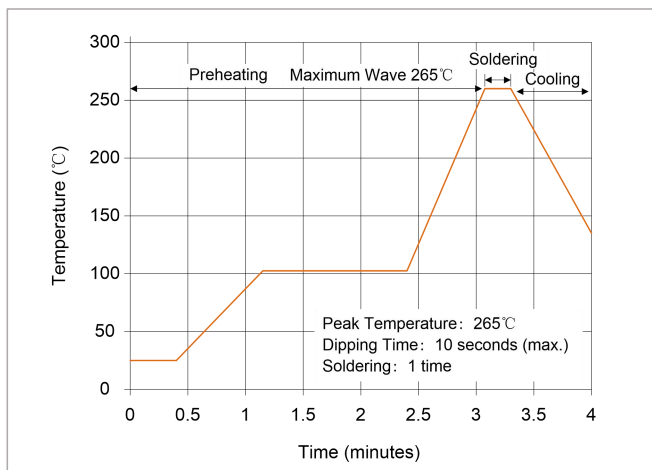

Flow/Wave Soldering (Solder Dipping)

Peak Temperature :	265°C
Dipping Time :	10 seconds (max.)
Soldering :	1 time

Ratings and Characteristic Curves ($T_A=25^\circ\text{C}$ unless otherwise noted)

Figure 2:
Power Derating Curve

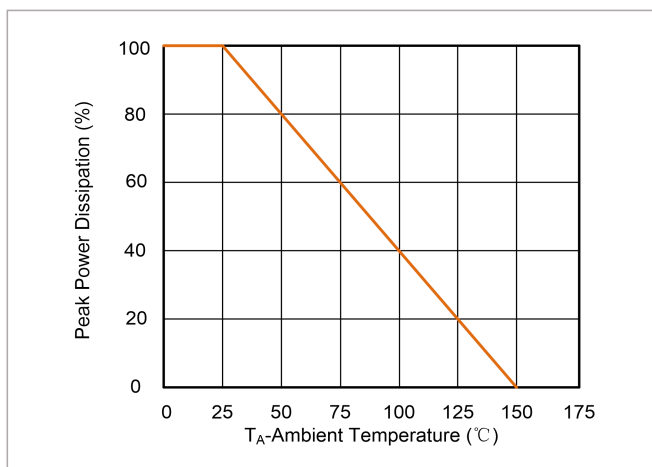
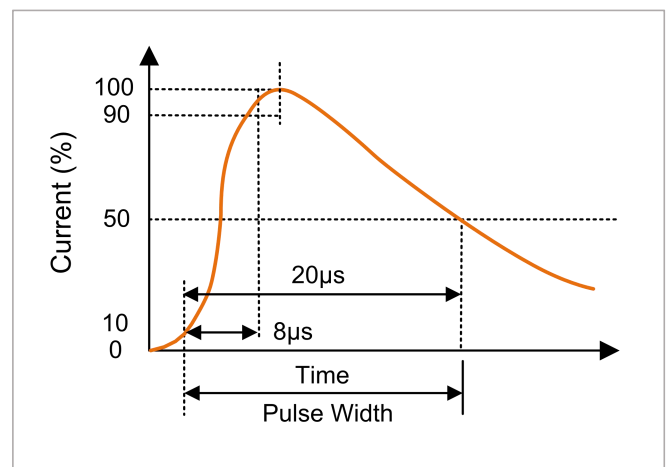

Figure 3:
Surge Pulse Waveform (8/20 μ s)



HP3KA-L Series

Axial Leaded – 3kA

Dimensions

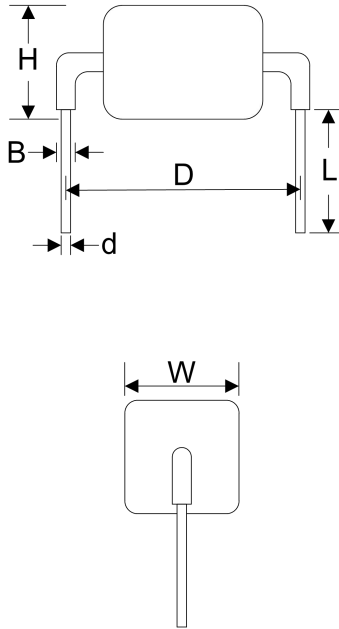

Symbol	12CL~380CL	
	Millimeters	Inches
D	24.15±1.0	0.951±0.039
B	1.35min	0.053min
H	13.0max	0.512max
L	6.0±1.20	0.236±0.047
d	1.28±0.10	0.050±0.004
W	13.0max	0.512max

Symbol	430CL~650CL	
	Millimeters	Inches
D	24.15±1.0	0.951±0.039
B	1.35min	0.053min
H	14.3max	0.563max
L	6.0±1.20	0.236±0.047
d	1.28±0.10	0.050±0.004
W	14.1max	0.555max

Symbol	1100CL~1200CL	
	Millimeters	Inches
D	27.0±1.0	1.063±0.039
B	1.35min	0.053min
H	14.3max	0.563max
L	6.0±1.20	0.236±0.047
d	1.28±0.10	0.050±0.004
W	14.1max	0.555max

Part Numbering System

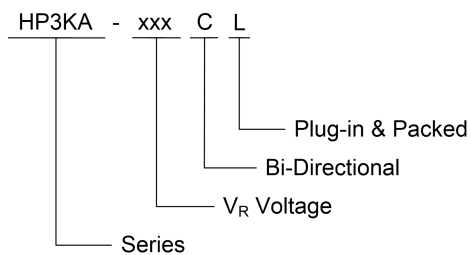

Part Marking System

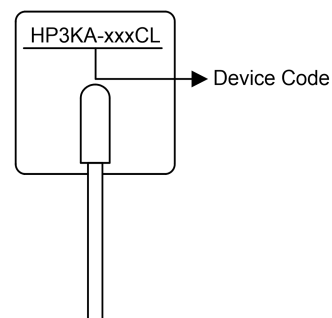

Packaging

Part number	Quantity	Packaging Option
HP3KA-xxxCL	80pcs/Box	Tray Pack

Disclaimer Notice - Information furnished is believed to be accurate and reliable. However, users should independently evaluate the suitability of and test each product selected for their own applications. Liown products are not designed for, and may not be used in, all applications. Read complete Disclaimer Notice at <http://www.liownsemi.com>